

Electronic Dice Kit

MitchElectronics 2019

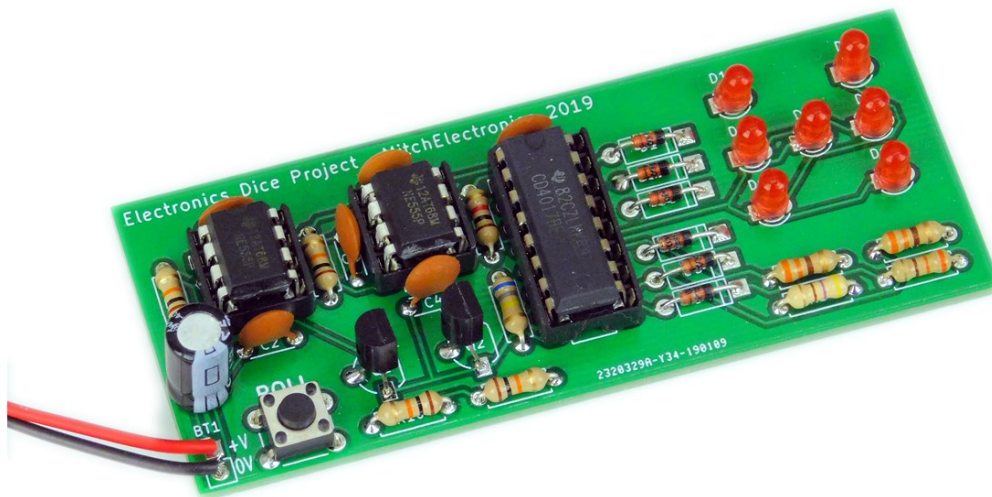

CONTENTS

Schematic ...	3
How It Works ...	4
Materials ...	5
Construction ...	6
Important Information ...	7

SCHEMATIC

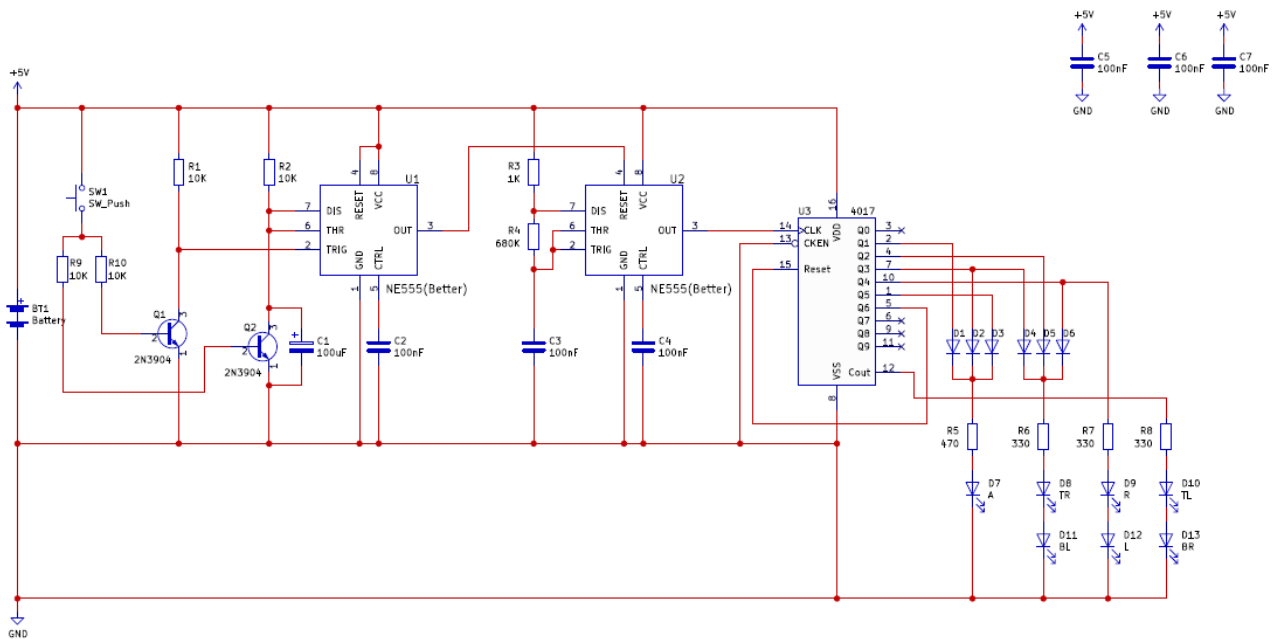

SCHEMATIC EXPLANATION

The Electronic Dice kit is an ... electronic dice ... which can be used in place of a dice for board games and other dice applications. When the user presses and holds the switch (SW1), the circuit rolls the dice and when the user lets go of the roll button the dice continues to roll for a short amount of time before landing on the final value.

This project relies on three main sub-circuits which include

- 555 Monostable circuit (U1)
- 555 Astable circuit (U2)
- 4017 counter (U3)

The function of the monostable and astable will not be covered here but can be learned from the other MitchElectronics kits found in the links bellow

- [555 Astable Kit](#)
- [555 Monostable Kit](#)

When the button is pressed and held the two transistors Q1 and Q2 are turned on. Q1 is connected to the trigger input of the 555 monostable U1 and so this causes the monostable to trigger. However, Q2 is connected across the timing capacitor C1 for the monostable and this discharges C1. C1 can only begin to charge when the user releases the button and so this is a 555 monostable that can be retriggered as well as held before starting the countdown.

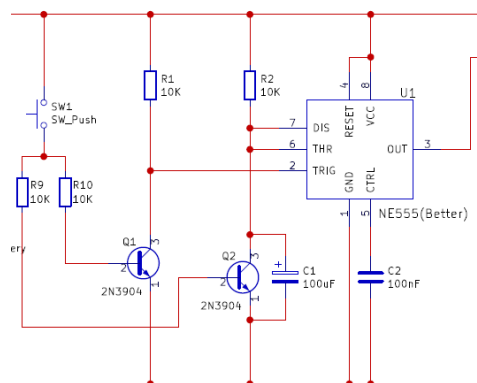

















A re-triggerable 555 monostable circuit

The 555 monostable (U1) is used to enable the 555 astable (U2) that acts as the clock source for the dice. Normally, the 555 monostable output is low and this keeps the 555 astable from oscillating but when the button is pressed and the monostable output goes high the 555 astable (U2) begins to oscillate. The 555 astable is connected to the 4017 counter's clock input so every time the 555 astable output (U2) goes from low to high the 4017 increments. The outputs of the 4017 are configured with diodes to create the pattern of the dice faces in the LEDs and upon counting more than 6 times the 4017 resets itself (by connecting Q6 which is the 7th output to the reset input).

MATERIALS

Check that you have the following components

Component	Component Name	Quantity	Looks like
4017 IC	U3	1	
555	U1, U2	2	
16 DIP Socket	U3	1	
8 DIP Socket	U1, U2	2	
2N3904 BJT	Q1, Q2	2	
330Ω Resistor	R6, R7, R8	3	
470Ω Resistor	R5	1	
1KΩ Resistor	R3	1	
10KΩ Resistor	R1, R2, R9, R10	4	
680KΩ Resistor	R4	1	
100nF Capacitor	C2, C3, C4, C5, C6, C7	6	
100uF Capacitor	C1	1	
Tactile Switch	SW1	1	
Red LED 3mm	D7, D8, D9, D10, D11, D12, D13	7	
1N4148	D1, D2, D3, D4, D5, D6	6	
PP3 Connector	BT1	1	

CONSTRUCTION

Download the electronics construction manual

To learn how to construct circuits on PCBs download the Electronics Construction Manual from MitchElectronics using the link below. This document shows you how to install all electronic components used in MitchElectronics kits. The list below shows the sections relevant to this kit so do not worry if you see component sections in the document that don't come with this kit!

www.mitchelectronics.co.uk/electronicsConstructionManual.pdf

Relevant sections in the electronics construction manual

- Resistors
- Capacitors
- LEDs and Diodes
- Transistors
- Switches
- Integrated Circuits
- Wires

RESISTOR AND CAPACITOR IDENTIFICATION

Colour	1 ST Band	2 ND Band	3 RD Band	Multiplier	Tolerance
BLACK	0	0	0	1Ω	
BROWN	1	1	1	10Ω	±1%
RED	2	2	2	100Ω	±2%
ORANGE	3	3	3	1kΩ	
YELLOW	4	4	4	10kΩ	
GREEN	5	5	5	100kΩ	±0.50%
BLUE	6	6	6	1MΩ	±0.25%
VIOLET	7	7	7	10MΩ	±0.10%
GREY	8	8	8		±0.05%
WHITE	9	9	9		
GOLD					±5%
SILVER					±10%

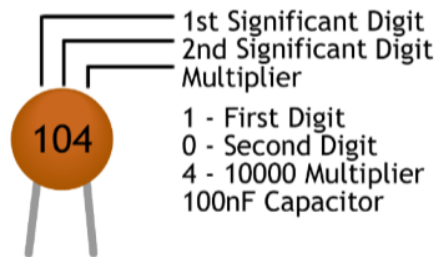
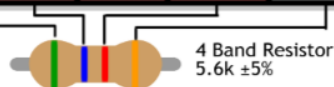

IMPORTANT INFORMATION



RoHS Compliant Kit (Lead free)



Low Voltage Kit



Caution! Soldering Required